

CONTROLLED MANIFOLD ASSEMBLIES



Working pressure 700 bar

Up to 4 outlets with individual control on each

Choice of manifolds for single or double acting systems

- ▶ Pressure gauges fitted to advance ports on all models
- ▶ Quick connect couplings fitted as standard to all inlet and outlet ports
- ▶ Precise control of oil flow and pressure within the hydraulic system

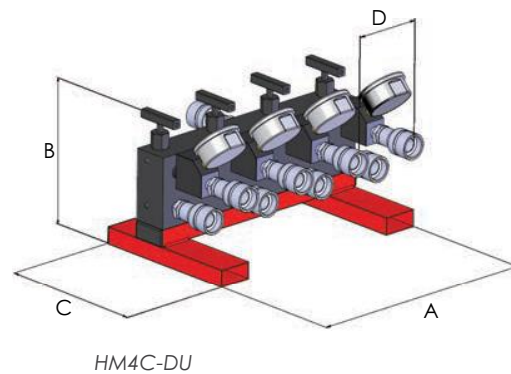
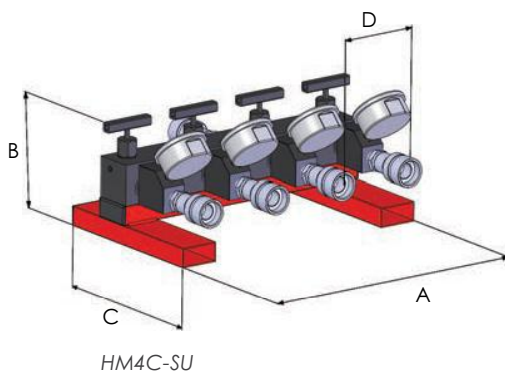
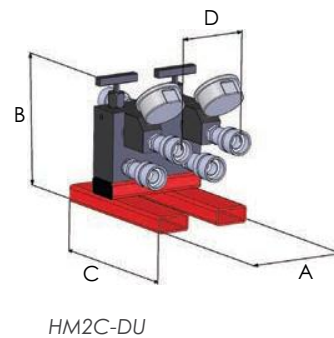
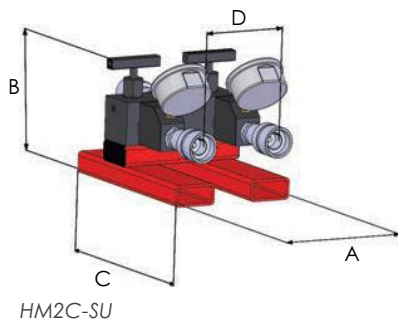

Model number	Description	Weight (kg)	Dimensions (mm)			
			A	B	C	D
HM2C-SU	2-way controlled manifold unit, suitable for single acting systems	2.0	150	51	51	100
HM2C-DU	2-way controlled manifold unit, suitable for double acting systems	3.0	150	102	51	100
HM4C-SU	4-way controlled manifold unit, suitable for single acting systems	3.5	350	51	51	100
HM4C-DU	4-way controlled manifold unit, suitable for double acting systems	6.0	350	102	51	100